

PERSPECTIVE VIEW

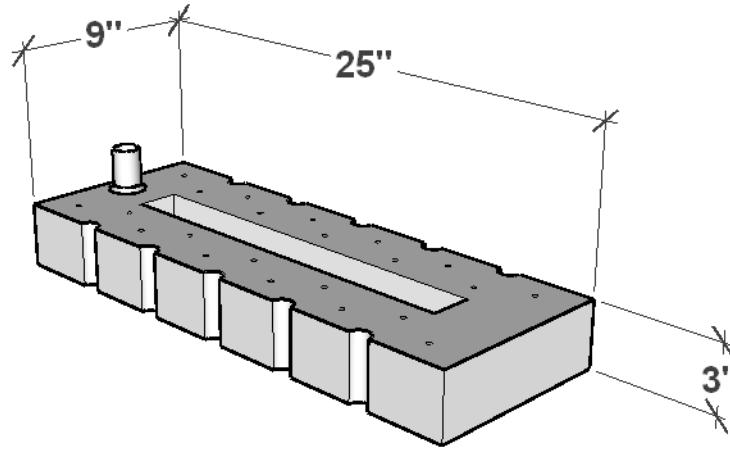

PLANTERS
UNLIMITED
 A CARLSBAD MANUFACTURING COMPANY

1 (888) 320-0626 | PlantersUnlimited.com

GENERAL NOTES	
STANDARD DRAINAGE: YES <input type="checkbox"/> NO <input type="checkbox"/>	

PRODUCT DESCRIPTION				SKU				PREPARED FOR	APPROVAL SIGNATURE
Rectangular Planter Well Reservoir				WW-REC-2593				-	
DIMENSIONS	MATERIAL	COLOR / FINISH	REP	DB	DATE	REV	ORDER #	PROJECT / SIDEMARK / IF#	APPROVAL DATE
25" x 9" x 3"H	-	N/A	N/A	IG	09/20/2024	1	N/A		